

Gene expression

By

Dr. Wasaa Bayoumie El Gazzar

Gene expression

- **Definition:** Gene expression can be defined as the gene (DNA) undergoes transcription into mRNA that can translate the encoded genetic information into protein.

Transcription (RNA synthesis)

- **Definition:** Transcription is the synthesis of RNA using DNA as a template by an enzyme DNA –dependent RNA polymerase or RNA polymerase (RNAP)

Features of transcription:

- One strand of the two DNA strands is transcribed only, this strand is called template strand (anti-sense), because it provides template for ordering the sequence of nucleotides in an RNA transcript.
- The other strand (non-transcribed) is called coding strand (sense strand), because its sequence is the same as the newly synthesized RNA transcript (except for thymine is substituted by uracil)

- The DNA template strand is read in 3' to 5' by RNA polymerase enzyme and the new RNA is synthesized in the direction of 5' to 3'.
- Upstream means in the 3' direction of the template strand.
- Downstream means in the 5' direction of the template strand.
- A transcription region is the nucleotide sequence transcribed by the enzyme RNAP. It is the region between the promoter and the terminator.

(i) Transcription unit

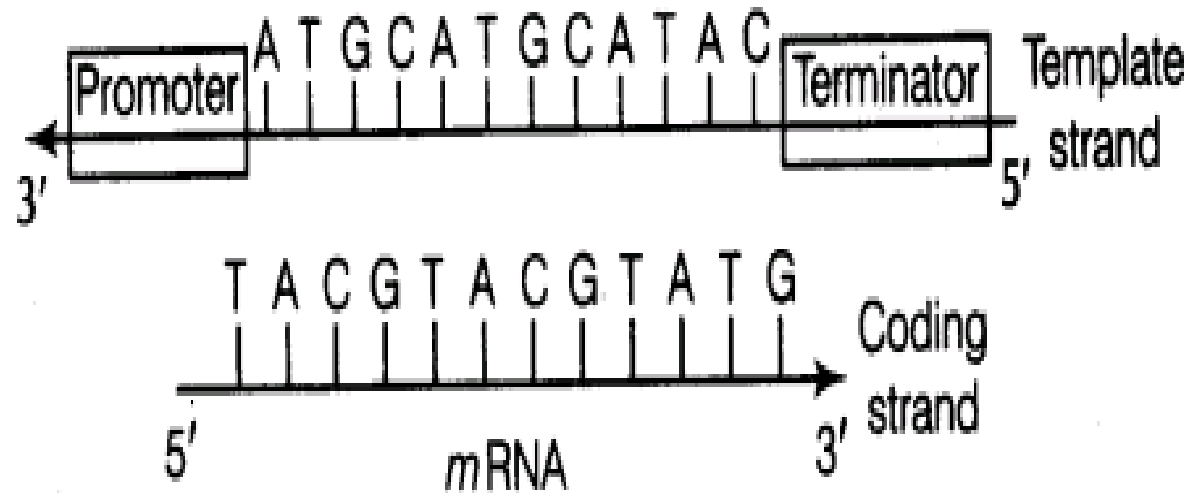

(ii) RNA transcribed



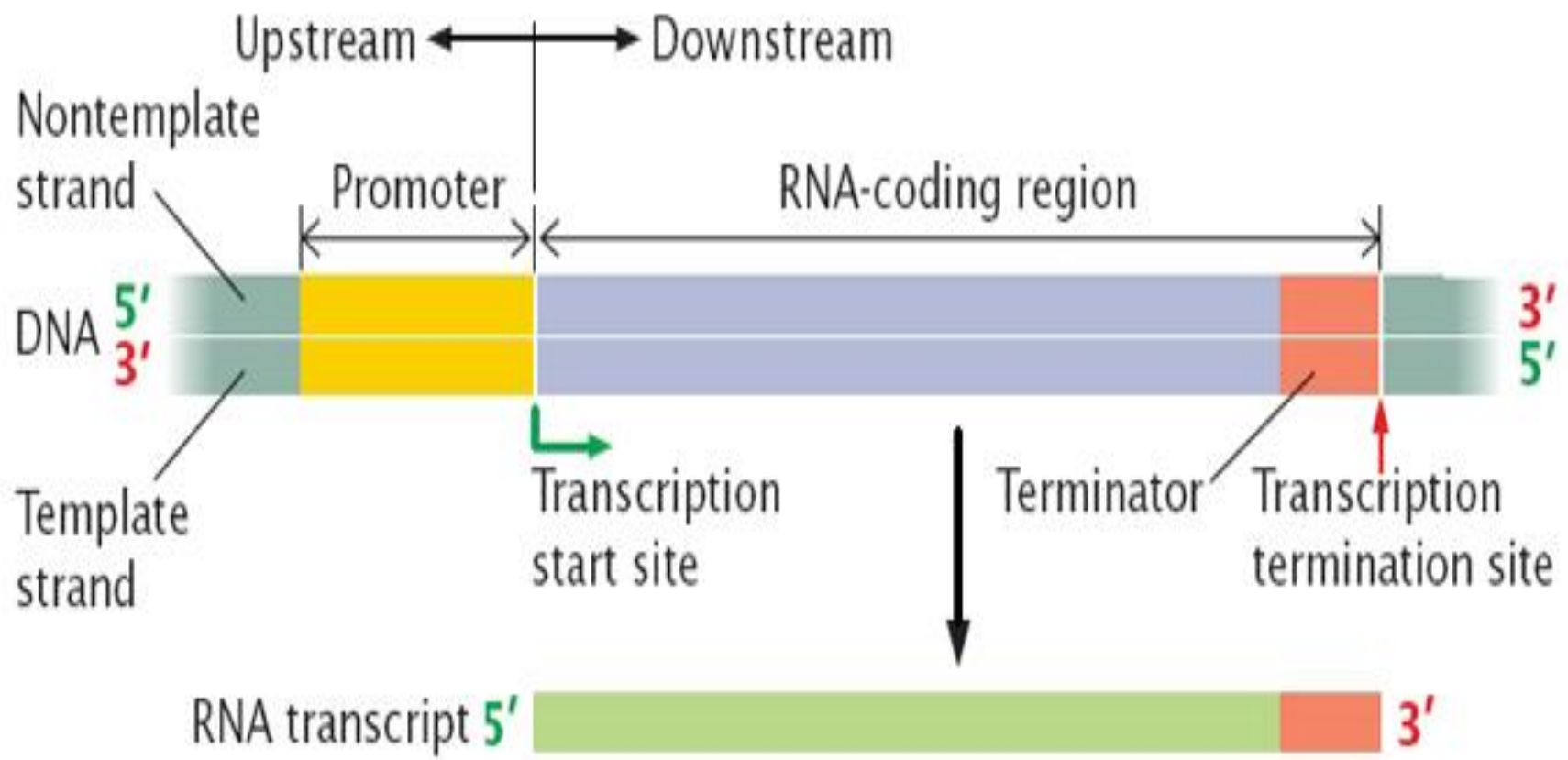

- **Promoter:** A promoter is the DNA sequence that initially binds the RNA polymerase (together with any initiation factors required). i.e. Nucleotide sequence in DNA to which RNA polymerase binds to begin transcription.
- **Terminator:** Sequences trigger the elongating polymerase to dissociate from the DNA and release the RNA chain it has made.
- **The start point** is the nucleotide at the 3` end of the transcription region "that codes for the initial base of the mRNA". It is designated +1. Adjacent nucleotides are given positive numbers that increase as we go downstream the transcription unit.

- The nucleotide in the promoter adjacent to the +1 nucleotide is designated -1 and adjacent nucleotides are given negative numbers that increase as we go upstream the promoter.
- The transcription unit Sequence of nucleotides in DNA that codes for a single RNA molecule, along with the sequences necessary for its transcription; normally contains a promoter, an RNA-coding sequence, and a terminator. (i.e. includes the promoter, the transcription region, and the terminator)

- The DNA nucleotide encoding the beginning of the RNA chain is called the transcription start site and is designated the “+1” position.
- Sequences in the direction in which transcription proceeds are referred to as **downstream** from the start site. Likewise, sequences preceding the start site are referred to as **upstream** sequences.
- When referring to a specific position in the upstream sequence, this is given a negative value. Downstream sequences are allotted positive values.

Transcription in prokaryotes:

- All types of RNA is synthesized by a specific enzyme called RNA polymerase **except** for the short RNA primers needed for DNA replication are synthesized by a primase enzyme.
- *** Structure of prokaryotic RNA polymerase:**
- It is a multi-subunit enzyme formed of core enzyme and sigma factor

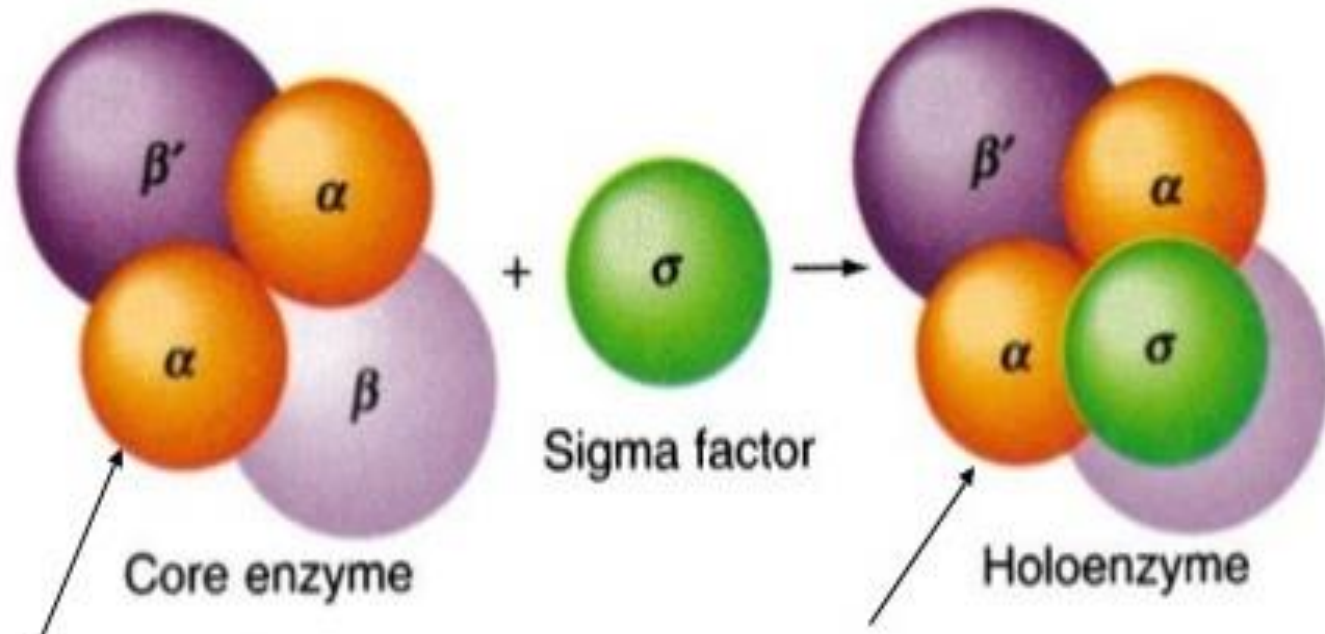

Required for polymerization activity

Required for correct initiation of transcription: ***binding to promoter***

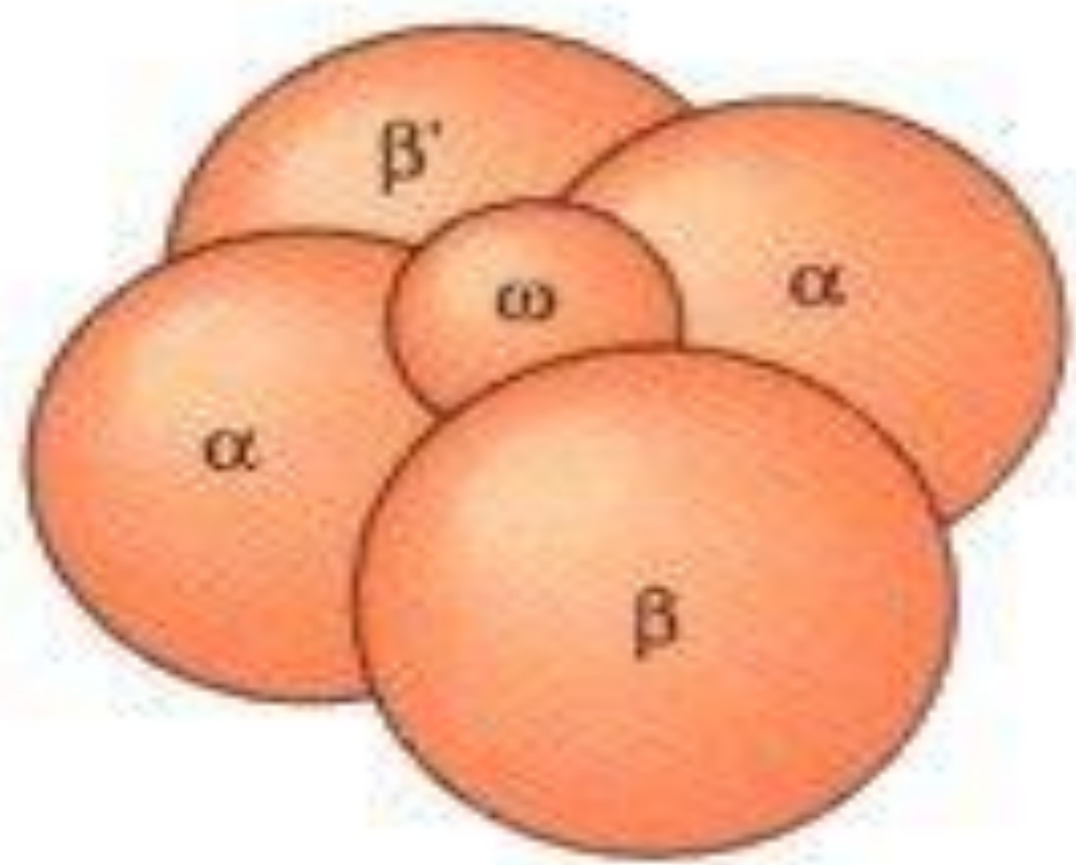

Core enzyme

- **Core enzyme:** two identical α subunits (regulatory subunits) and two β not identical (β & β') and one ω chain. One of the β subunits (β) binds to the DNA and the other (β') is responsible for the formation of phosphodiester bond.
-  *RNA polymerase enzyme lacks specificity, that is, it cannot recognize the promoter region on the DNA template.*
- **The σ subunit (“sigma factor”):** It enables RNA polymerase to recognize promoter regions on the DNA. The σ subunit plus the core enzyme make up the holoenzyme. [Note: Different σ factors recognize different groups of genes.]

☀ **N.B.:** The antibiotic rifampicin binds to the β subunits of RNA polymerase and inhibits RNA synthesis in prokaryotes as it interferes with the formation of the first phosphodiester bond. Rifampicin is useful in the treatment of tuberculosis.

Steps of RNA synthesis in prokaryotes:

- It is divided into three phases: initiation, elongation and termination.

Initiation:

- It involves the binding of RNA polymerase to a specific region on the DNA known as the promoter region formed of specific base sequence. It needs a specific protein factor called sigma factor (σ) that recognizes and binds to the promoter region at the TATA box then RNA polymerase starts transcription at the start point (+1) it is the first base transcribed as RNA.

- The characteristic nucleotide sequences of the prokaryotic promoter region (as indicated in the coding strand in the 5` to 3` direction) include:

✿ **TATA box**: It is formed of six nucleotides (TATAAT) and is located 10 bases upstream (i.e. usually occurs around base-10)to the start point (+1 point).It determines where transcription starts.

✿ **The (TTGACA) box**: this sequence is 35 bases upstream to the start point (located at -35 base i.e. centered about 35 bases to the left of the transcription start site) .It determines the frequency of transcription

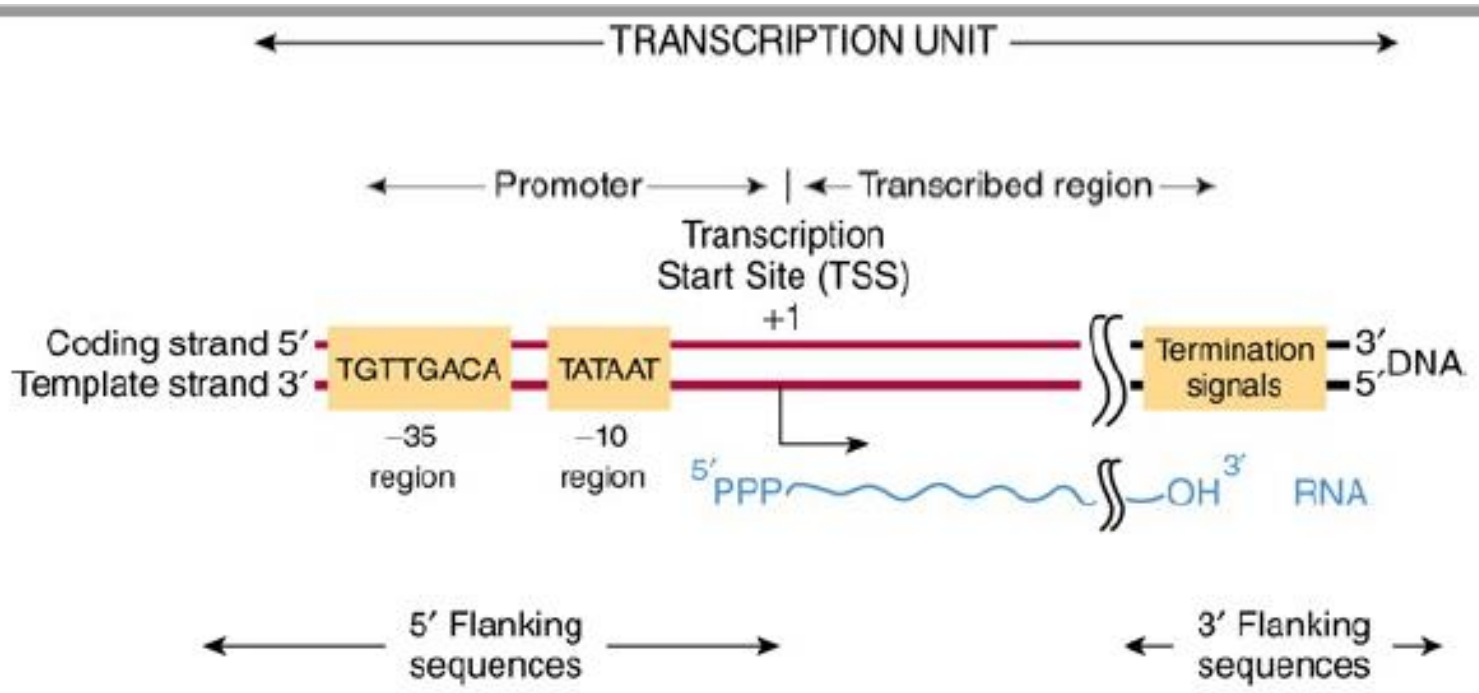

Source: Murray RK, Bender DA, Botham KM, Kennelly PJ, Rodwell VW, Weil PA: *Harper's Illustrated Biochemistry, 29th Edition*: www.accessmedicine.com

Copyright © The McGraw-Hill Companies, Inc. All rights reserved.

Elongation:

- In prokaryotes only **one** type of RNA polymerase synthesizes the three types of prokaryotic RNA.
- The binding of RNA polymerase to DNA template produce local unwinding of the DNA double helix to expose the bases.
- The enzyme begins to synthesize RNA in the direction of 5' to 3' with the base sequence complementary to that of the DNA template strand. Sigma factor is released after initiation of transcription.
- The core enzyme moves along the DNA template uses ribonucleoside triphosphate (ATP, GTP, CTP & UTP) and releases pyrophosphate

- Unlike DNA polymerase, RNA polymerase does not require a primer and has intrinsic helicase activity, therefore no separate enzyme is needed to unwind the DNA (in contrast to DNA polymerase).
- RNAP not only initiates RNA transcription, it also guides the nucleotides into position, facilitates attachment and elongation, has intrinsic proofreading (It doesn't not possess a proof reading feature as efficient as the DNA polymerase but it possesses the capability of correct some misadded nucleotide as well) and replacement capabilities, and termination recognition capability.

Termination:

- RNA polymerase recognizes a termination signal at the end of the DNA sequence to be transcribed (termination sequence). Then RNA polymerase stop transcription and releases RNA molecule.

- *There are two mechanisms for transcription termination:*

1-Rho factor dependent termination (ATP dependent)

2-Rho factor independent termination (intrinsic termination)

1-Rho-dependent termination:

- It uses a **termination factor called ρ factor** (rho factor) which is a protein that binds at a **rho utilization site** (*rut*) on the nascent RNA strand (cytosine-rich sequence) and runs along the mRNA towards the RNAP (in a 5'-3' direction).

(The rut serves as a mRNA loading site and as an activator for Rho)

- The rho protein is an **ATP dependent RNA-DNA helicase**
- when ρ -factor reaches the RNAP, it causes RNAP to dissociate from the DNA, terminating transcription.

- **Rho is able to catch up with the RNA polymerase. Contact between Rho and the RNA polymerase complex stimulates dissociation of the transcriptional complex through a mechanism involving allosteric effects of Rho on RNA polymerase.**

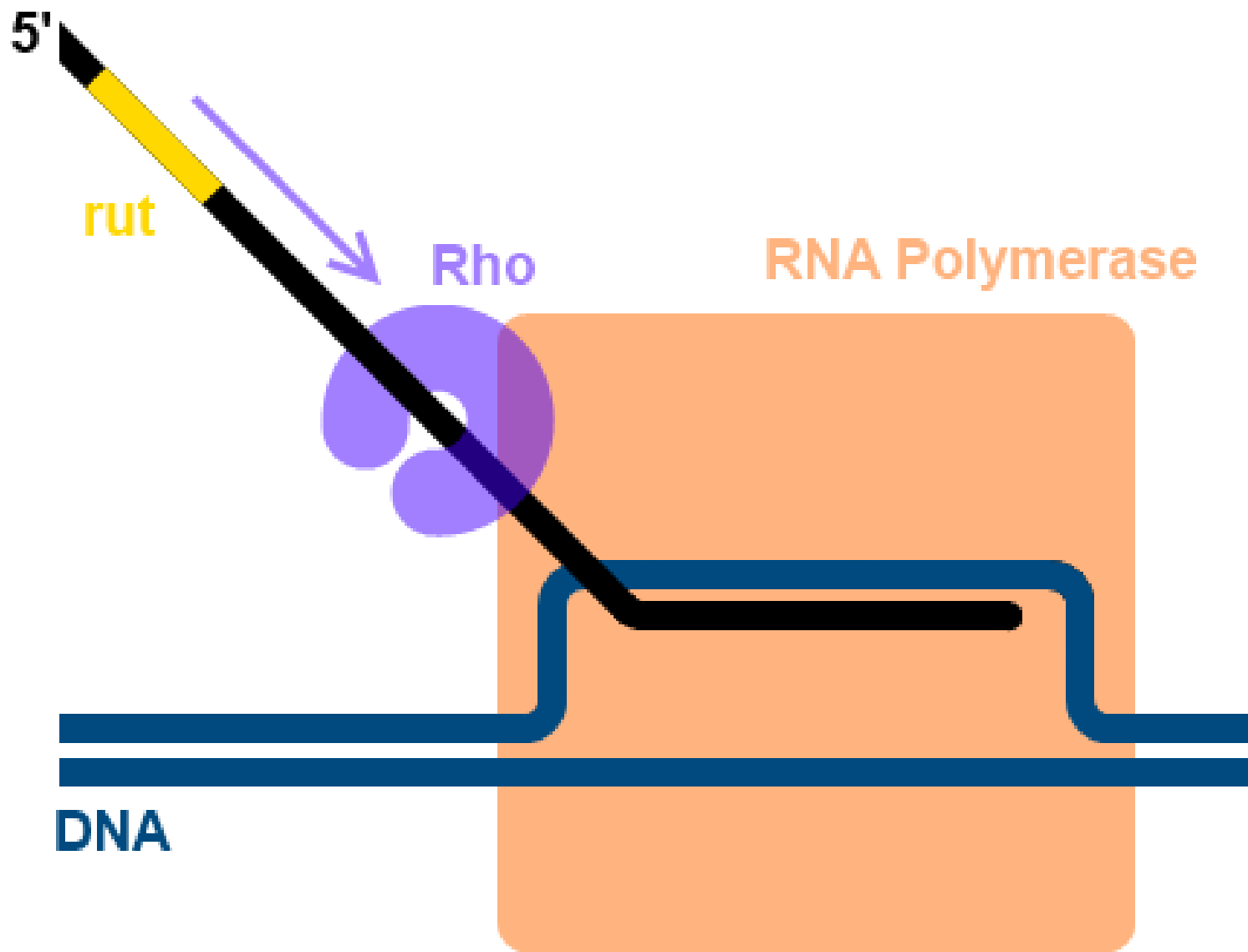

2-Rho factor independent termination (intrinsic termination):

- The termination sequences is self-complementary sequences rich in GC that are present at the 3' end of mRNA. These complementary bases join each other forming hairpin loop like structure that leads to dissociation of RNA from the DNA and release the RNA polymerase enzyme.

- The termination site is characterized by the presence of two regions that are separated by a few bases (4-6) in the form of a palindrome.
- DNA palindrome: A palindromic sequence is a nucleic acid sequence on double-stranded DNA wherein reading 5' to 3' forward on one strand matches the sequence reading 5' to 3' on the complementary strand with which it forms a double helix. (form symmetrical inverted repeat).
- When the RNA is created, the inverted repeats can loop back on themselves to form a hairpin loop, which acts as a termination signal.

← Two fold symmetry →

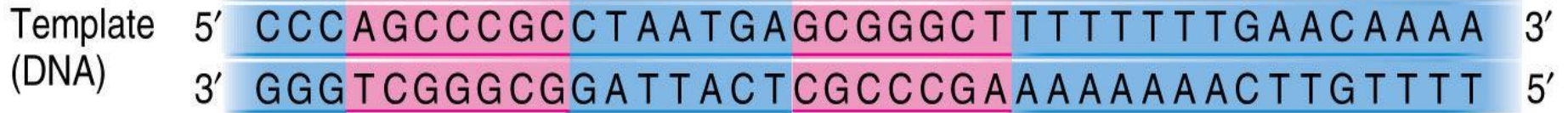

Transcript folded to form termination hairpin

