

Properties of cardiac muscle

Dr. Waleed R. Ezzat

Lecture Objectives:

1. Describe automaticity and conduction of the conductive system of the heart; the control role of the ANS
2. Describe cardiac muscle action potential and its components.
3. Describe certain fundamental properties of cardiac muscle such as conductivity, refractory period and excitation contraction coupling.

The Pacemaker and the conducting system of the heart

- ⦿ SA node – specialized cardiac muscle, have almost no contractile muscle filaments, connected directly with the atrial muscle fibers, responsible for autorhythmicity (*self-excitation*). It is the **pacemaker** of the heart. The normal rate of the SA node is 70 to 80 times per minute.
- ⦿ Internodal and interatrial bands – responsible for conduction (velocity is about 1m/sec).
- ⦿ AV node – located in the posterior wall of the right atrium immediately behind the tricuspid valve, *delay* conduction due to diminished numbers of gap junctions (acts as a *physiological blocker*), conduction is unidirectional (*one-way conduction*).
- ⦿ Bundle of His – conduction.
- ⦿ Rt. and Lt. Bundle Branch – conduction, lie beneath the endocardium.
- ⦿ Purkinje fibers – have the highest rate of conduction (4m/sec, average in myocardium is 0.3-0.5 m/sec). *Prevent fibrillation*. Cardiac impulse travels from the endocardial surface to the epicardial surface of the ventricle.

The conducting system of the heart

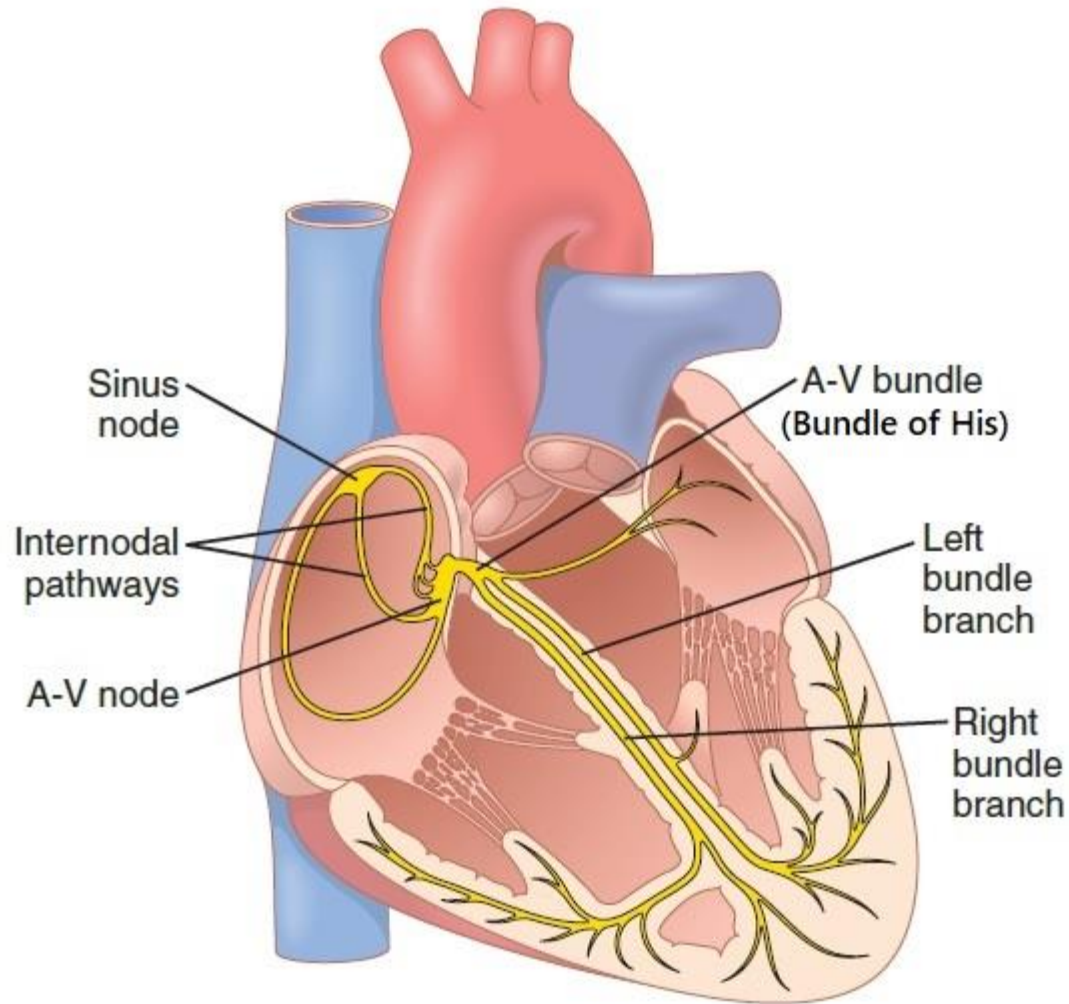

Sinus node and the Purkinje system of the heart, showing also the atrioventricular (A-V) node, atrial internodal pathways, and ventricular bundle branches.

Autonomic Nerves Control of Cardiac Rhythmicity and Impulse Conduction

- ⊙ The heart is supplied with both sympathetic and parasympathetic nerves.
- ⊙ The parasympathetic nerves are distributed mainly to the SA and AV nodes, and to a lesser extent to the muscle of the two atria.
- ⊙ The sympathetic nerves, conversely, are distributed to *all parts* of the heart.
- ⊙ Parasympathetic (vagal) stimulation **slows** the cardiac rhythm and conduction. This effect is mediated through the action of acetylcholine (ACh) on muscarinic receptors. In other words, vagal stimulation to the heart causes;
 - Negative chronotropic effect = ↓ heart rate (i.e. *Bradycardia*)
 - Negative dromotropic effects = ↓ AV nodal conduction = ↑ AV nodal delay
- ⊙ Sympathetic stimulation **increases** the overall activity of the heart through the activation of β_1 adrenergic receptors. In other words, sympathetic stimulation to the heart causes;
 - Positive chronotropic effect = ↑ heart rate (i.e. *Tachycardia*)
 - Positive dromotropic effects = ↑ AV nodal conduction = ↓ AV nodal delay
 - Positive inotropic effect = ↑ myocardial *contractility*

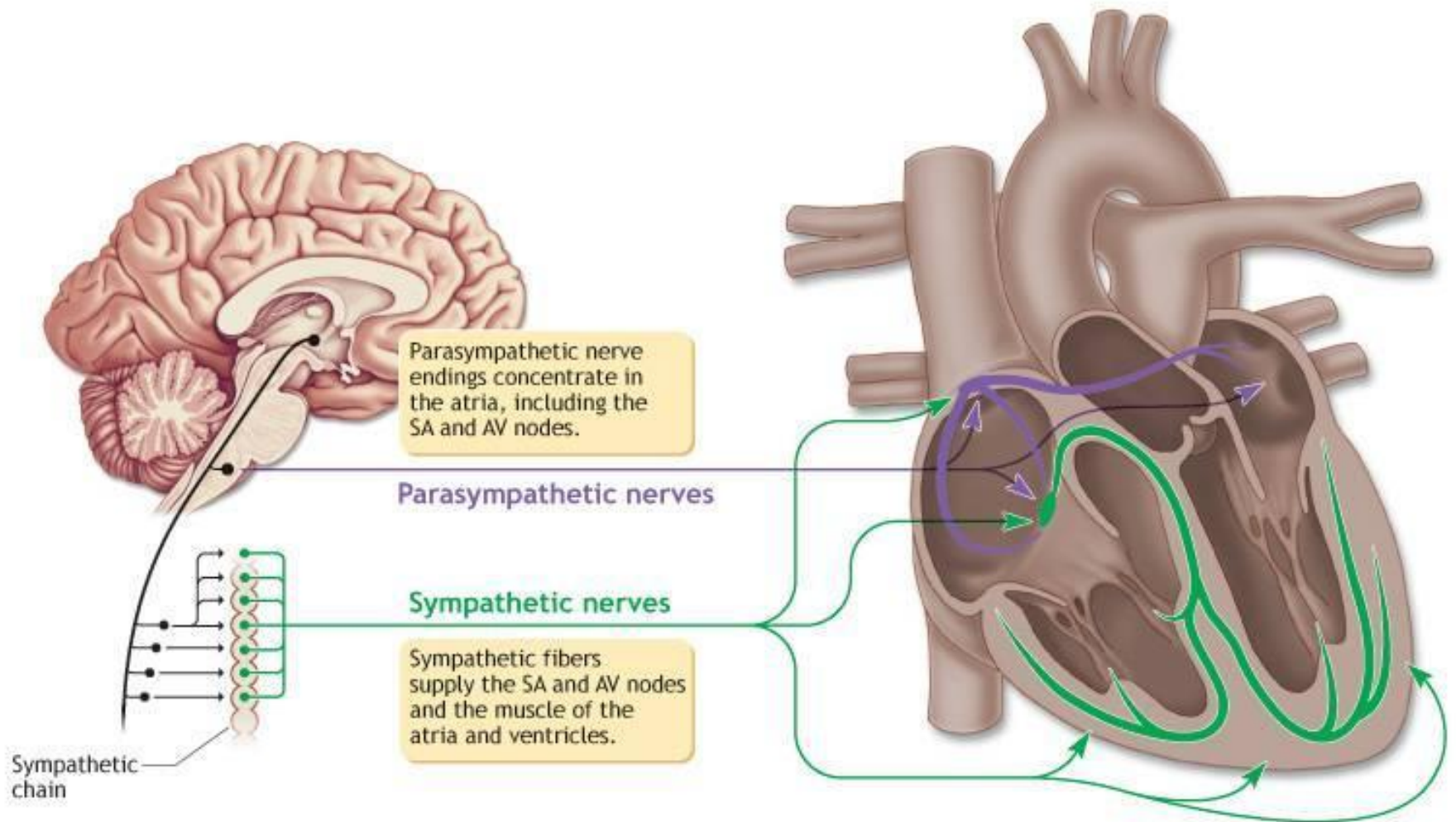
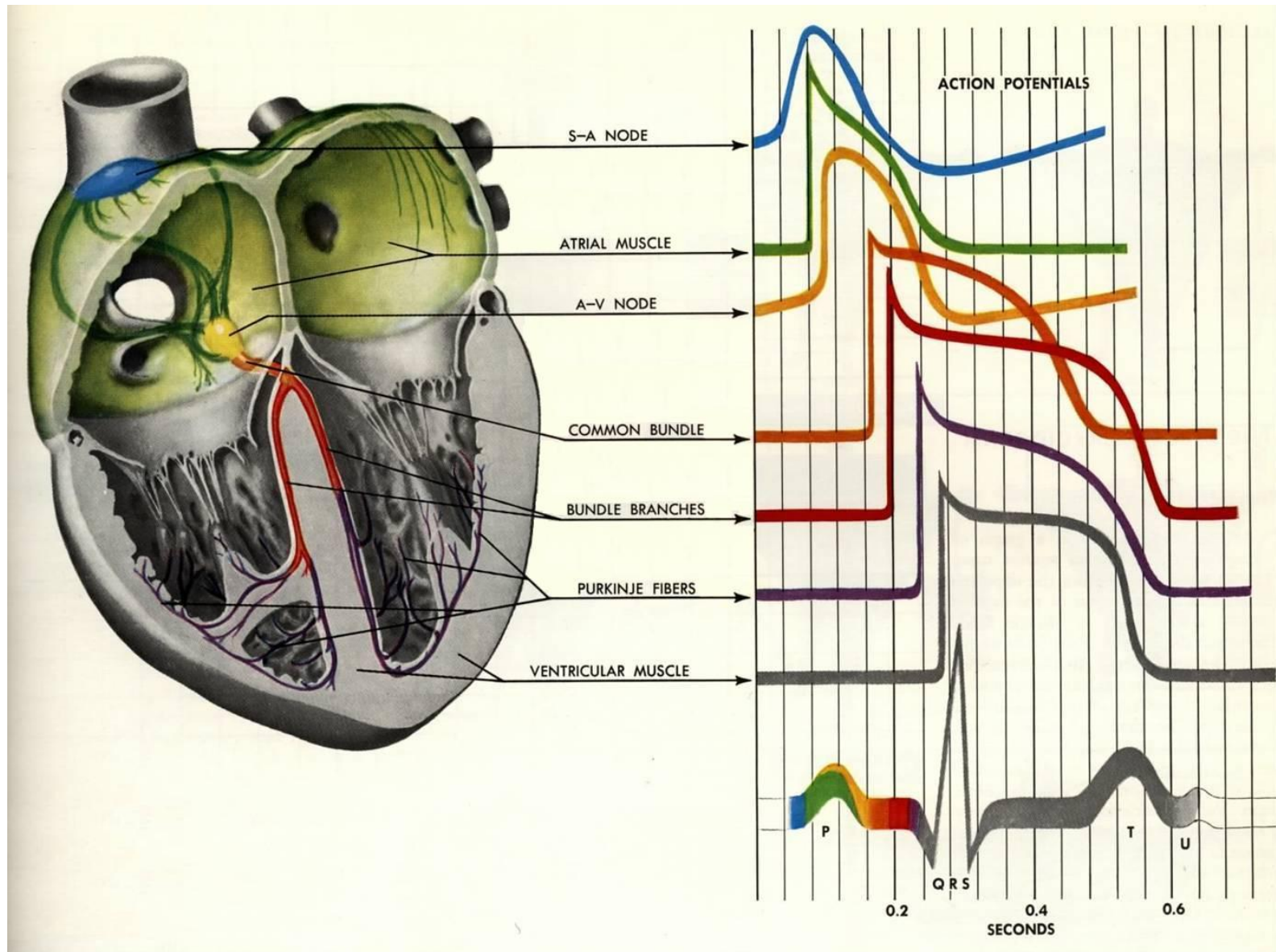

Figure Distribution of sympathetic and parasympathetic nerve fibers to the myocardium. Sympathetic nerve fiber endings secrete the neuro-hormone epinephrine. Sympathetic fibers supply the SA and AV nodes and the muscle of the atria and ventricles. Parasympathetic nerve endings secrete acetylcholine. These fibers concentrate in the atria, including the SA and AV nodes.

The Cardiac Action Potentials



The pacemaker and non-pacemaker action potential

Non-pacemaker AP (Fast response AP):

1. Divided into five phases; 0, 1, 2, 3, and 4.
2. Found in normal atrial and ventricular myocytes and in the specialized conducting fibers (e.g. Purkinje fibers)

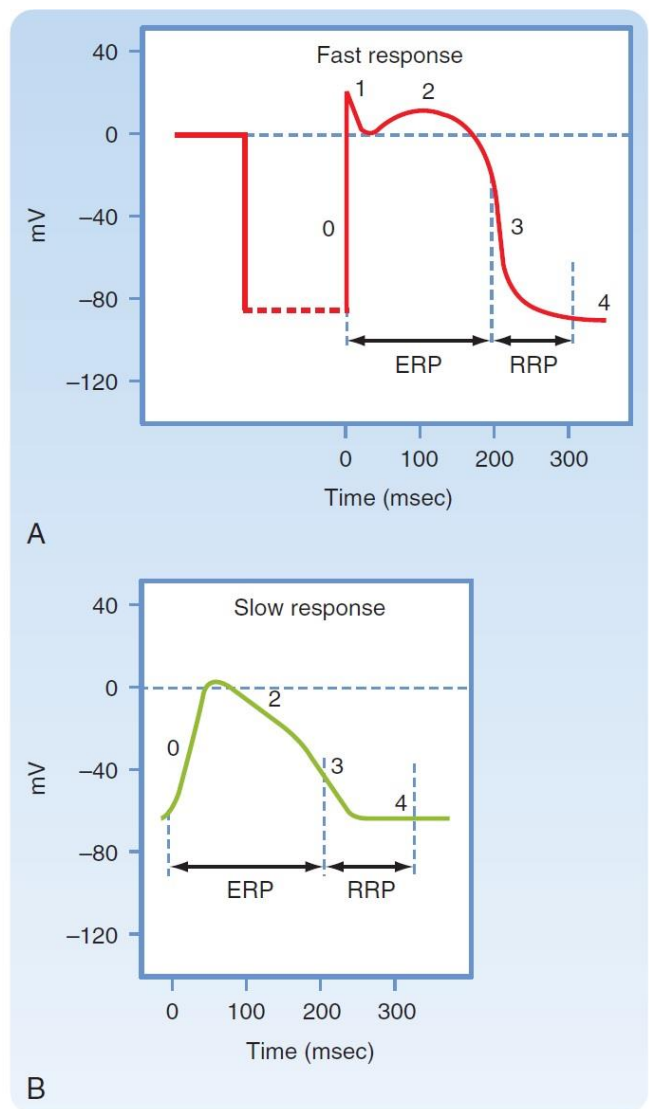

Action Potentials of Cardiac Fibers

A, Fast-response cardiac fibers.

B, Slow-response cardiac fibers.

The phases of the action potentials are labeled, as are the effective refractory period (ERP) and the relative refractory period (RRP). Note that in comparison with fast-response fibers, the resting potential of slow fibers is less negative, the upstroke (phase 0) of the action potential is less steep, the amplitude of the action potential is smaller, phase 1 is absent, and the RRP extends well into phase 4 after the fibers have fully repolarized.

Components of The Non-pacemaker Action Potential

- ◎ Phase 0 (*The rapid depolarization phase*). Is due to rapid influx of Na^+ when the resting membrane potential (V_m), is suddenly depolarized from -90 mV to the threshold level of approximately -65 mV. The voltage-activated fast sodium channels will be inactivated (closed) at the end of phase 0 (at about $+20$ mV) and will not be fully reactivated only when V_m has returned to the resting level (phase 4).
- ◎ Phase 1 (*early repolarization phase*). Is due to activation of a transient outward potassium current (i_{to}) \rightarrow brief efflux of K^+ .
- ◎ Phase 2 (*plateau*). Is due to Ca^{2+} enters myocardial cells through slow calcium-sodium channels (mainly L-type). The influx of Ca^{2+} is counterbalanced by the efflux of K^+ . K^+ exits through channels that conduct mainly the i_{to} , i_K , and i_{K1} currents. Excessive loss of K^+ from the cell during the plateau phase is achieved by a sudden decrease in K^+ conductance, a phenomenon called *inward rectification*. L-type channels are activated during phase 0 when V_m reaches approximately -20 mV. L-type channels are blocked by **calcium channel antagonists** such as verapamil, amlodipine, and diltiazem. The adrenergic neurotransmitter norepinephrine and other β -adrenergic receptor agonists enhance Ca influx, whereas the parasympathetic neurotransmitter acetylcholine decreases Ca influx. Enhancement of Ca influx is the principal mechanism by which they enhance cardiac muscle contractility (i.e. positive inotropic effect).

Phase 0 of The Fast Fiber Action Potential

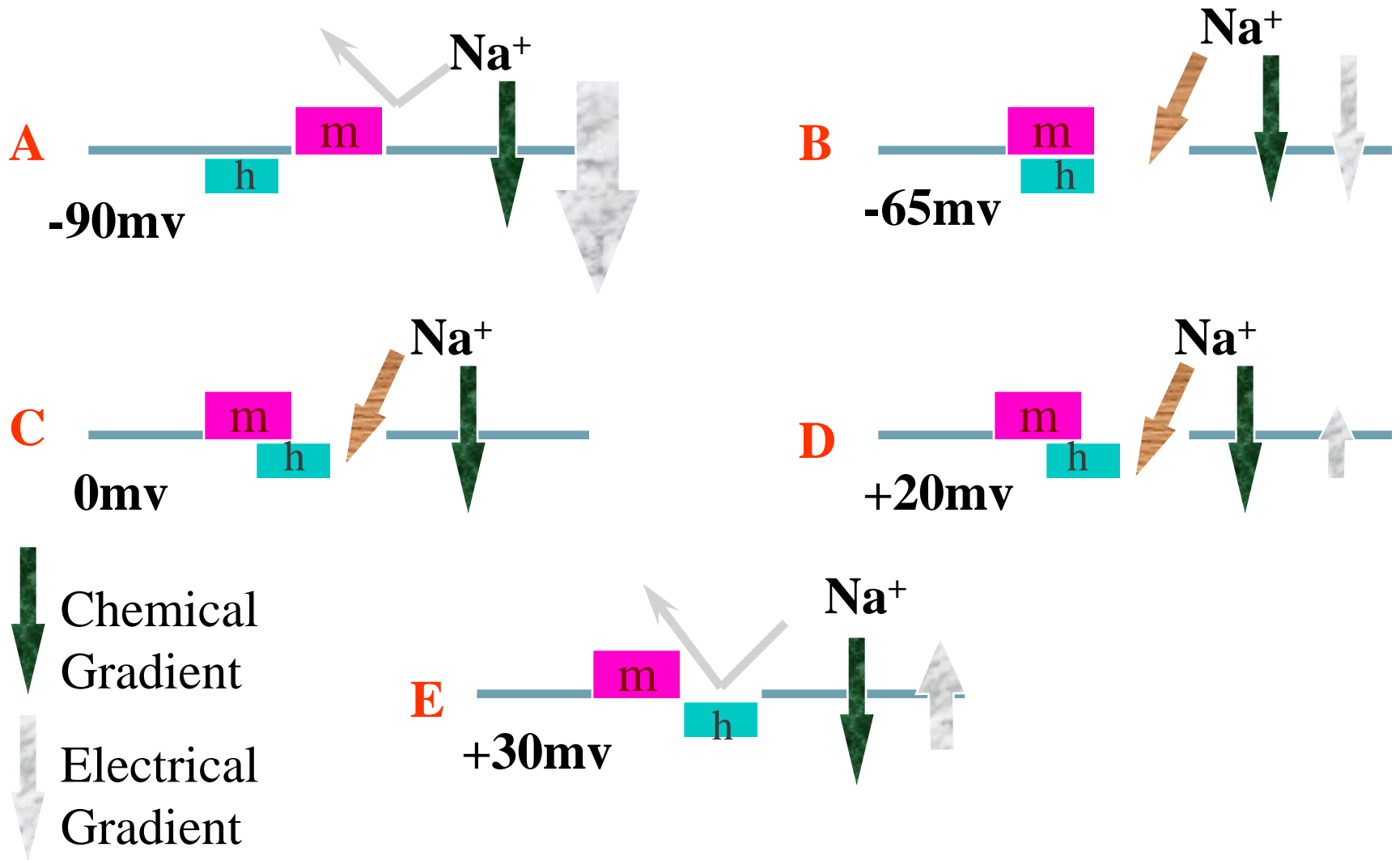

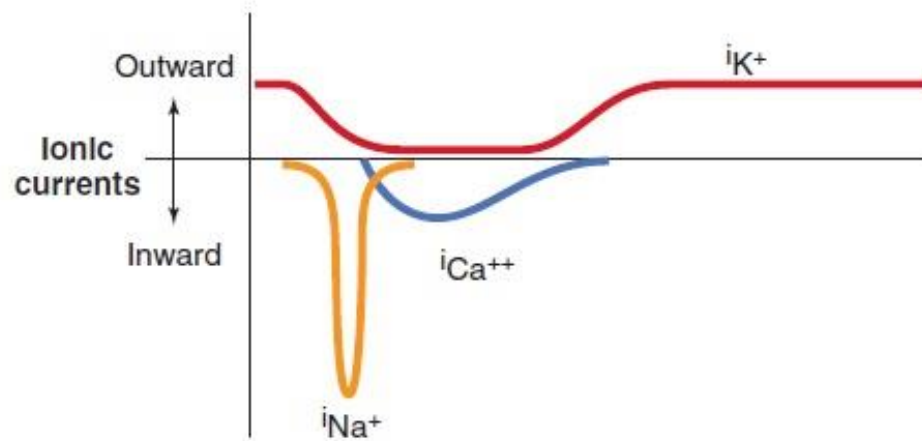
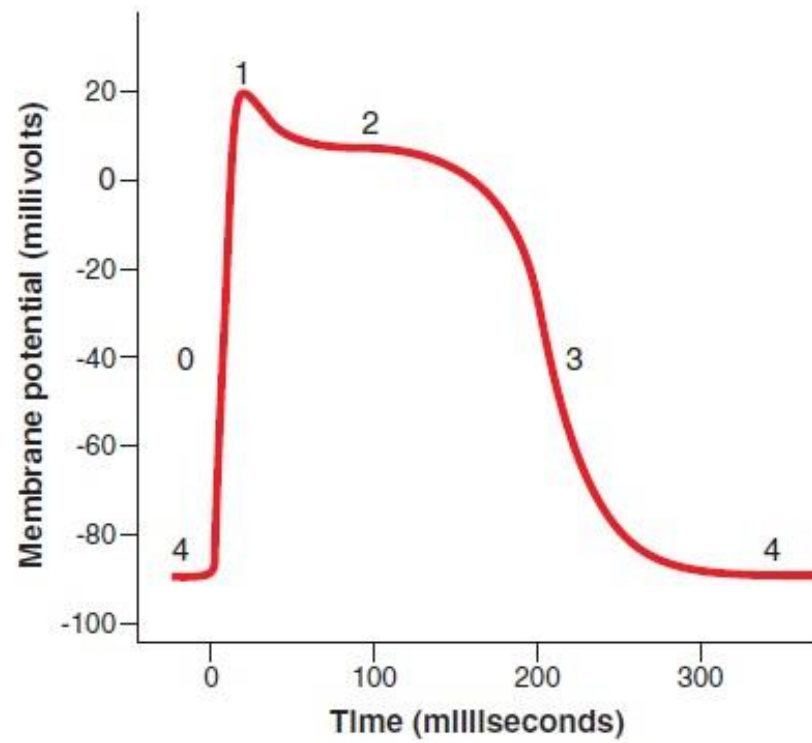
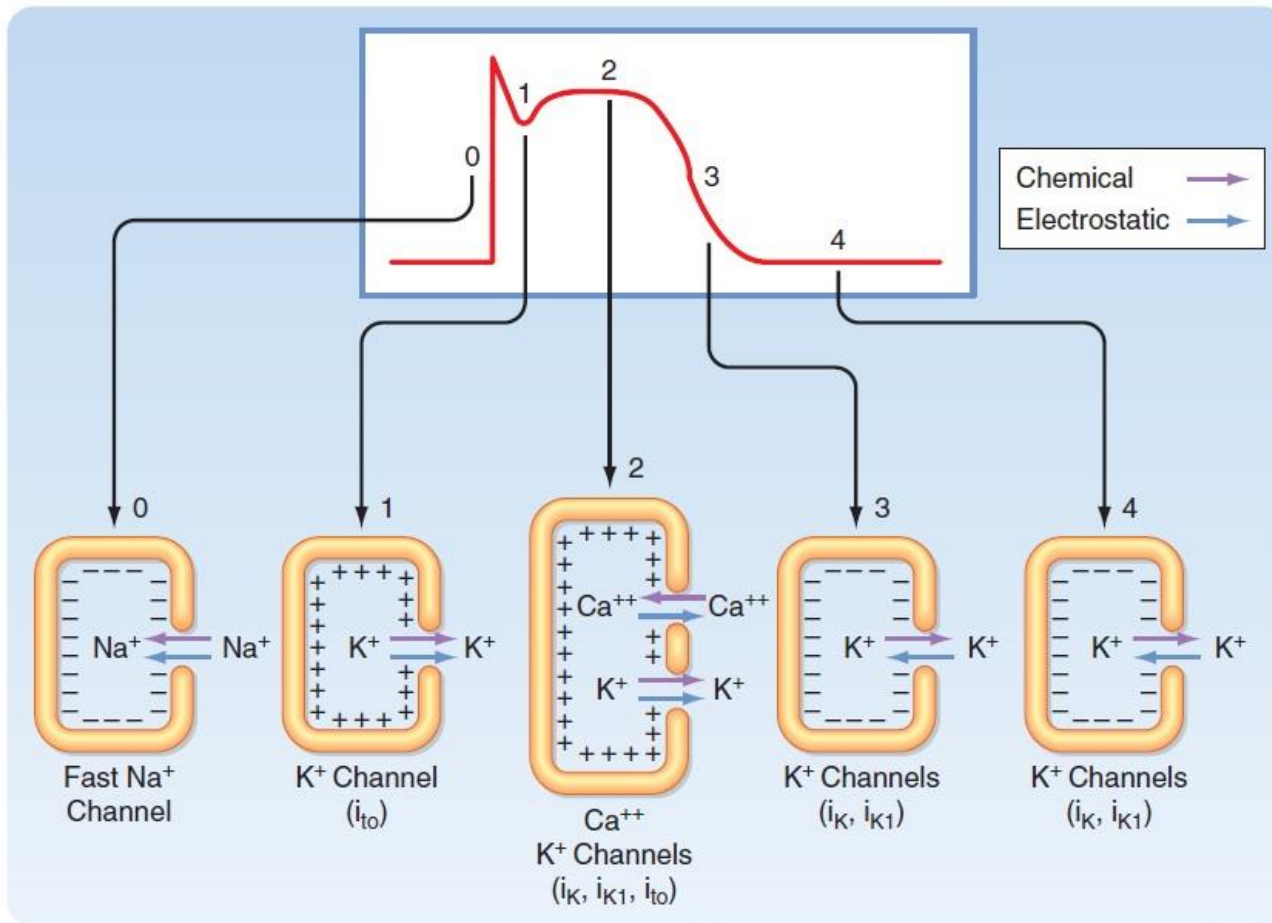

Figure Phases of action potential of cardiac ventricular muscle cell and associated ionic currents for sodium (i_{Na^+}), calcium ($i_{Ca^{++}}$), and potassium (i_{K^+}).

Components of The Non-pacemaker Action Potential (cont.)

- ◎ Phase 3 (*rapid repolarization phase*). Starts at the end of phase 2, when efflux of K^+ from the cardiac cell begins to exceed influx of Ca^{2+} . The i_{to} and i_K currents help initiate repolarization. The i_{K1} channels contribute substantially to the rate of repolarization once phase 3 has been initiated. As V_m becomes increasingly negative during phase 3, the conductance of the channels that carry the i_{K1} current progressively increases and thereby accelerates repolarization.
- ◎ Phase 4 (*resting membrane potential*). In a resting cardiac cell, K^+ conductance is approximately 100 times greater than Na^+ conductance. Therefore, membrane potential (V_m) is similar to the Nernst equilibrium potential for K^+ . As a result, alterations in extracellular $[K^+]$ can significantly change V_m . Hypokalemia causes hyperpolarization, and hyperkalemia causes depolarization. In contrast, because Na^+ conductance is so small in the resting cell, changes in extracellular $[Na^+]$ do not significantly affect V_m . Most of the excess Ca^{2+} ions that had entered the cell mainly during phase 2 are eliminated principally by a $3Na^+-Ca^{2+}$ antiporter, which exchanges three Na^+ ions for one Ca^{2+} ion. However, some of the Ca^{2+} ions are eliminated by an ATP-driven Ca^{2+} pump.



Principal Ionic Currents and Channels That Generate the Various Phases of the Action Potential in a Cardiac Cell. **Phase 0**, The chemical and electrostatic forces both favor the entry of Na^+ into the cell through fast sodium channels to generate the upstroke. **Phase 1**, Both the chemical and electrostatic forces favor the efflux of K^+ through transient outward current (i_{to}) channels to generate early, partial repolarization. **Phase 2**, During the plateau, the net influx of Ca^{++} through calcium channels is balanced by the efflux of K^+ through outward rectifying current (i_k), inward rectifying current (i_{k1}), and i_{to} channels. **Phase 3**, The chemical forces that favor the efflux of K^+ through i_k and i_{k1} channels predominate over the electrostatic forces that favor the influx of K^+ through these same channels. **Phase 4**, The chemical forces that favor the efflux of K^+ through i_k and i_{k1} channels very slightly exceed the electrostatic forces that favor the influx of K^+ through these same channels.

The pacemaker AP (Slow response AP)

- ⦿ The slow response type of action potential occurs in the sinoatrial (SA) node and in the atrioventricular (AV) node.
- ⦿ The slow-response cells lack the early repolarization phase (phase 1).
- ⦿ The slope of the upstroke (phase 0), the amplitude of the action potential, and the overshoot are greater in the fast-response cells than in the slow-response cells.
- ⦿ The plateau is less prolonged and not as flat, and the transition from the plateau to the final repolarization is less distinct.
- ⦿ Depolarization is achieved mainly by influx of Ca^{2+} through L-type calcium channels instead of influx of Na^{+} through fast sodium channels.
- ⦿ Repolarization is accomplished in these fibers by inactivation of the calcium channels and by the increased K^{+} conductance through the i_{K1} and i_K channels.

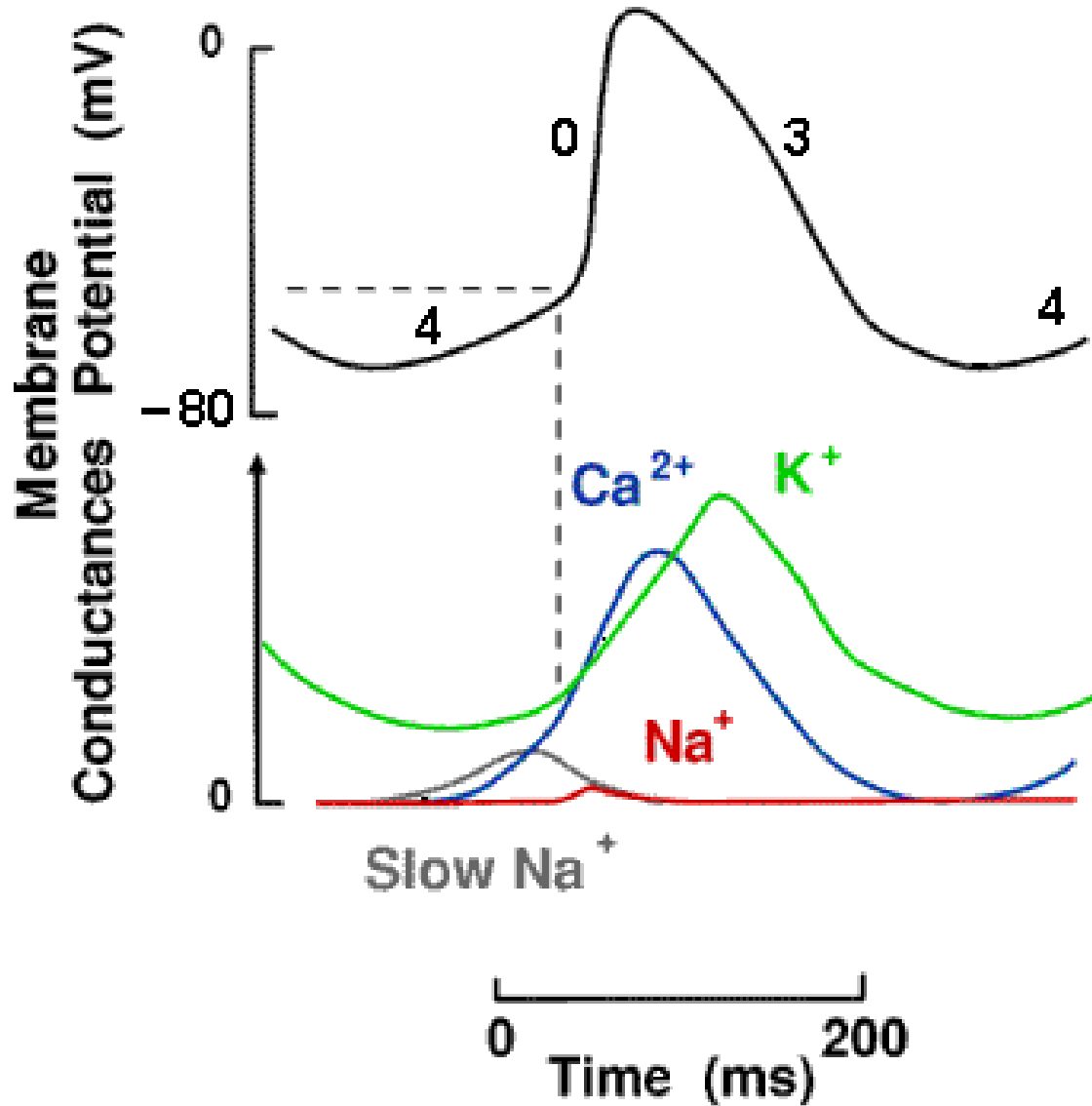

The pacemaker AP (Slow response AP) cont.

- ⊙ The principal parameters of the pacemaker action potential are;
 1. The threshold potential (about -40 mV)
 2. The slow diastolic depolarization throughout phase 4 (Prepotential)
 3. The maximal repolarization potential (maximal negativity during phase 4, about -55 to -60 mV)
- ⊙ The progressive diastolic depolarization is mediated by the funny current, i_f and i_{Ca} currents, which oppose the repolarizing effect of the i_K current.
- ⊙ The inward current i_f is activated near the end of repolarization and is carried mainly by Na^+ through specific channels that differ from the fast sodium channels. This current is activated as the membrane potential becomes hyperpolarized beyond -50 mV. The more negative the membrane potential at this time, the greater the activation of i_f .
- ⊙ Pacemaker cell frequency may be varied by a change in any of the above three parameters

Note:

1. Ach hyperpolarizes nodal membranes and decreases the slope of the prepotentials. This effect is due to increased K^+ conductance of nodal tissue (mediated by M_2 muscarinic receptors stimulation) → decreased firing rate
2. Temperature and Thyroxin → increase discharge frequency
3. Digitalis → depresses nodular tissue and exerts an effect similar to vagal stimulation especially on AV node

Characteristics of The Pacemaker Potential

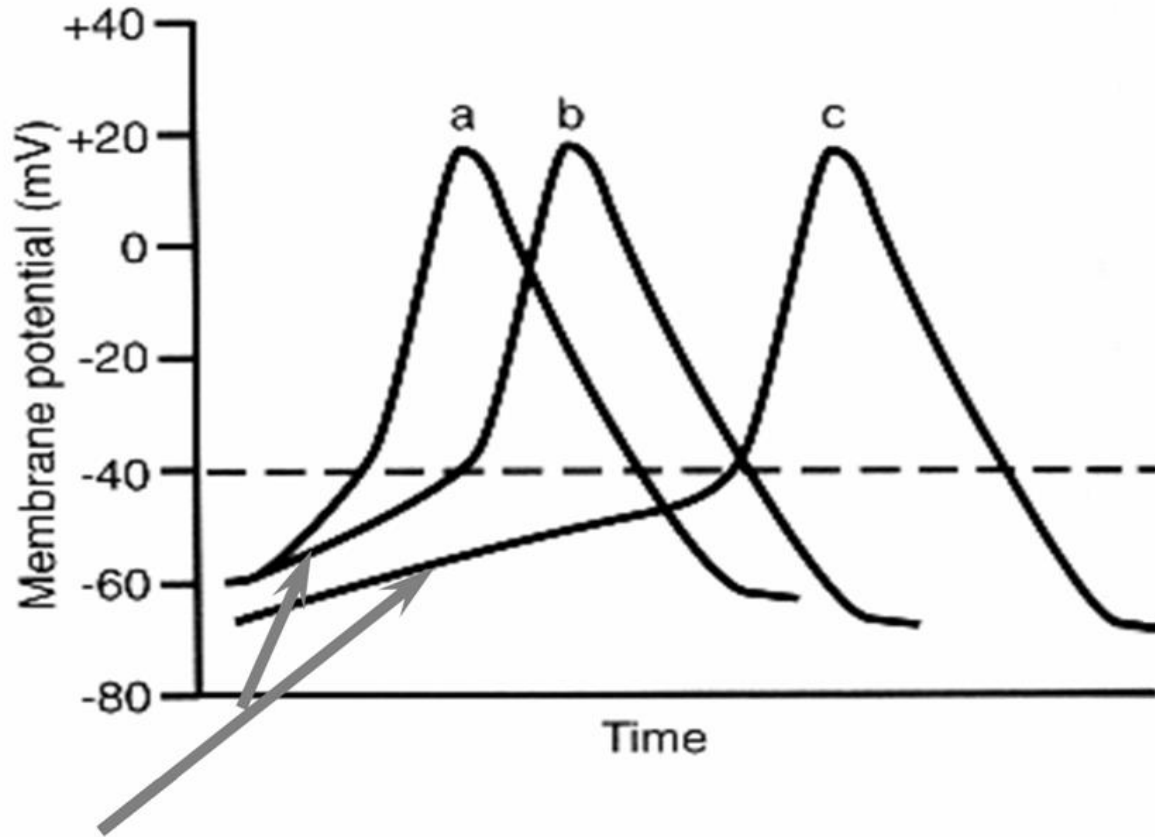

Recall: **Phase 4** Pacemaker Potential Observed Here.

Frequency Depends on: Threshold, Max. Repolarization Potentials and Slope of The Prepotential

The Cardiac refractory periods

1. In the fast response, the effective (or Absolute) refractory period, ERP (0.25-0.30 sec) extends from the beginning of phase 0 to a point in phase 3 at which repolarization has reached approximately -50 mV. The myocardium is no longer excitable during this interval.
2. The relative refractory period (0.05 sec) extends from the end of ERP till complete repolarization. An action potential may be evoked only when the stimulus is stronger than a stimulus that could elicit a response during phase 4.
3. In slow-response fibers, the relative refractory period frequently extends well beyond phase 3. Even after the cell has completely repolarized, it may be difficult to evoke a propagated response for some time.
 - Refractory period of atrial muscle is shorter than that for ventricles (0.15 versus 0.25-0.30 sec).
 - The refractory period prevents the chance of tetanization.

The Effective or Absolute Refractory Period (Fast Fiber)

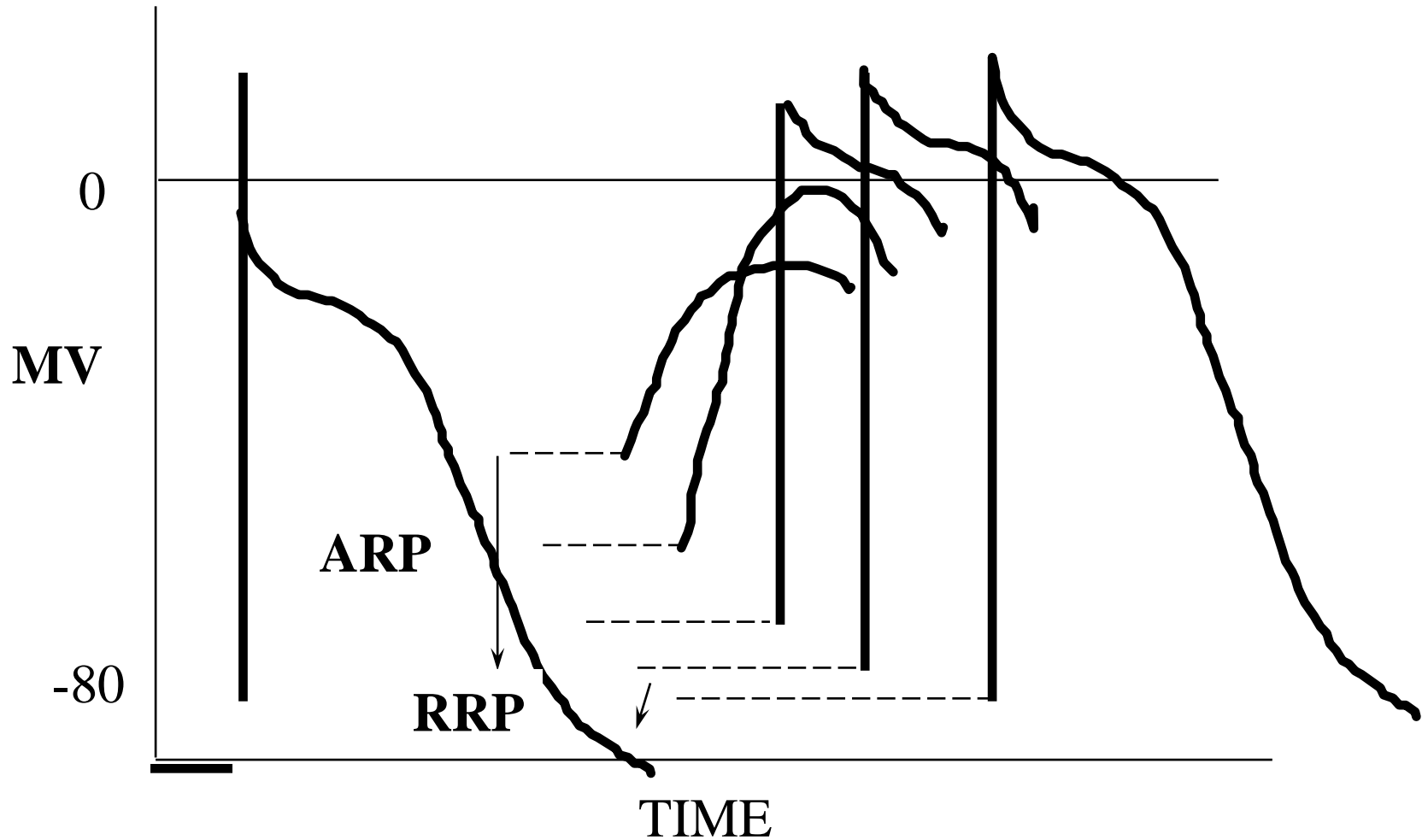

Membrane Potential (mV)

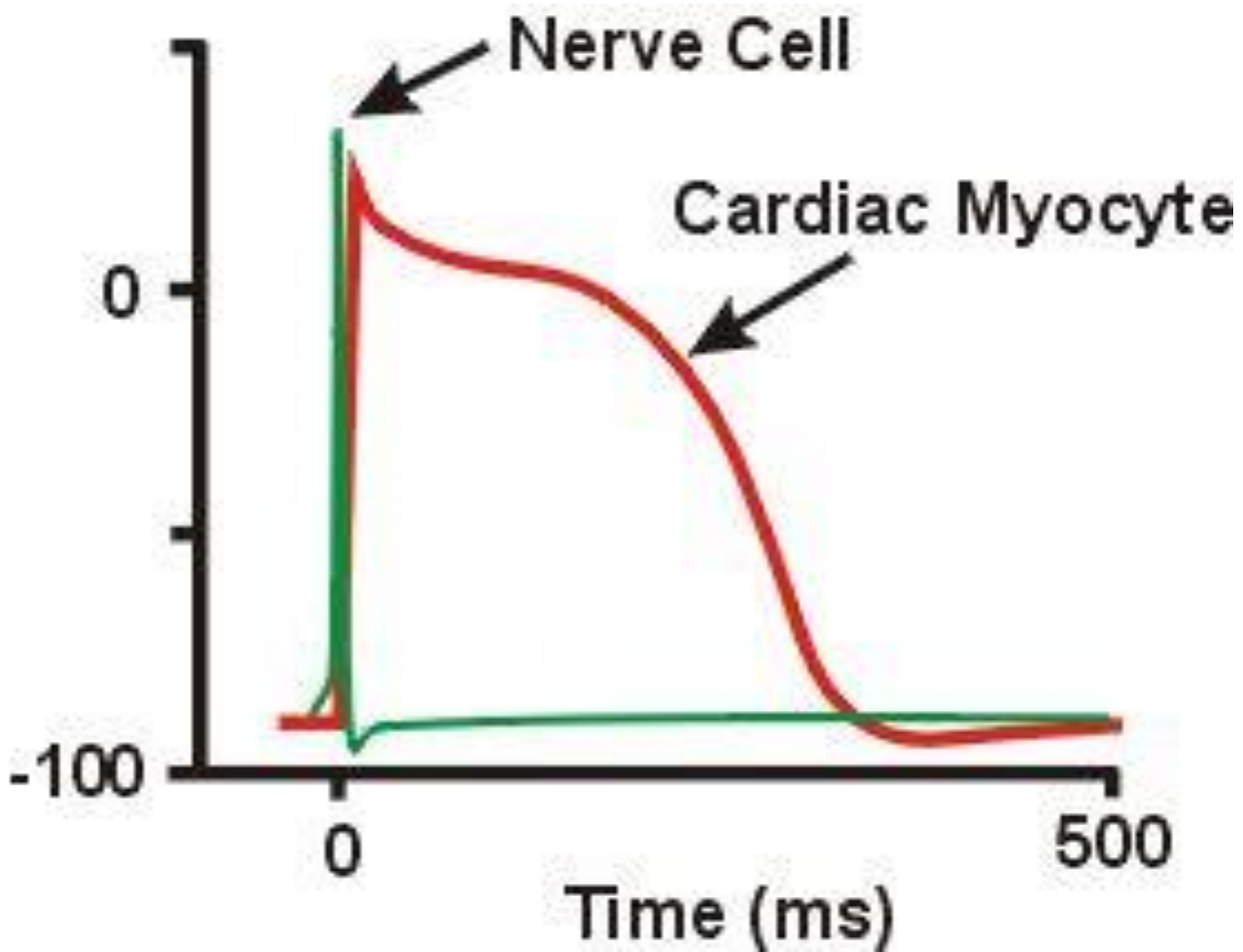

Nerve Cell

Cardiac Myocyte

Time (ms)

Refractory Period

- ◆ **LONG** (*250 msec*)
- ◆ membrane is refractory to further stimulation until the contraction is over

➔ **NO SUMMATION OR TETANY POSSIBLE!**

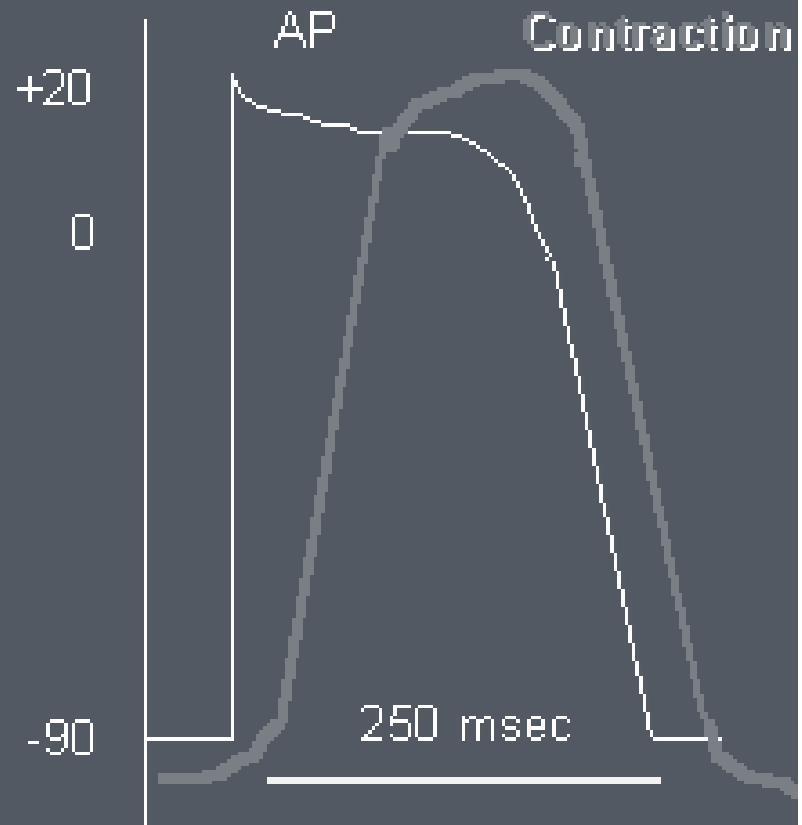

Excitation-Contraction Coupling (role of Ca²⁺ kinetics)

- ⊙ The mechanism of the excitation-contraction coupling in cardiac muscle is the same as that for skeletal muscle with some differences that have important effects on the characteristics of heart muscle contraction.
- ⊙ Large quantity of extracellular Ca²⁺ ion diffuses into the myocardial sarcoplasm from the wide T- tubules.
- ⊙ Calcium entering the cell (via L-type calcium channel) then activates *calcium release channels*, also called *ryanodine receptor channels*, in the sarcoplasmic reticulum membrane, triggering the release of calcium into the sarcoplasm. This is referred to as Calcium induce-Calcium release mechanism..
- ⊙ Cytoplasmic [Ca²⁺] increases from a resting level of approximately 10⁻⁷ mol to levels of approximately 10⁻⁵ mol during excitation. This Ca²⁺ then binds to the protein troponin C.
- ⊙ Strength of contraction is directly related to the extracellular calcium and rate of calcium influx (e.g. as during sympathetic stimulation)
- ⊙ The duration of contraction of cardiac muscle is mainly a function of the duration of the action potential, *including the plateau*.
- ⊙ Both cardiac contraction and relaxation are accelerated by catecholamines. Catecholamines increase intracellular cAMP levels, which then leads to activation of cAMP-dependent protein kinase A.

Protein kinase A → phosphorylation of L-type calcium channels → ↑ calcium influx

Protein kinase A → phosphorylation of phospholamban → ↑ calcium uptake into the sarcoplasmic reticulum

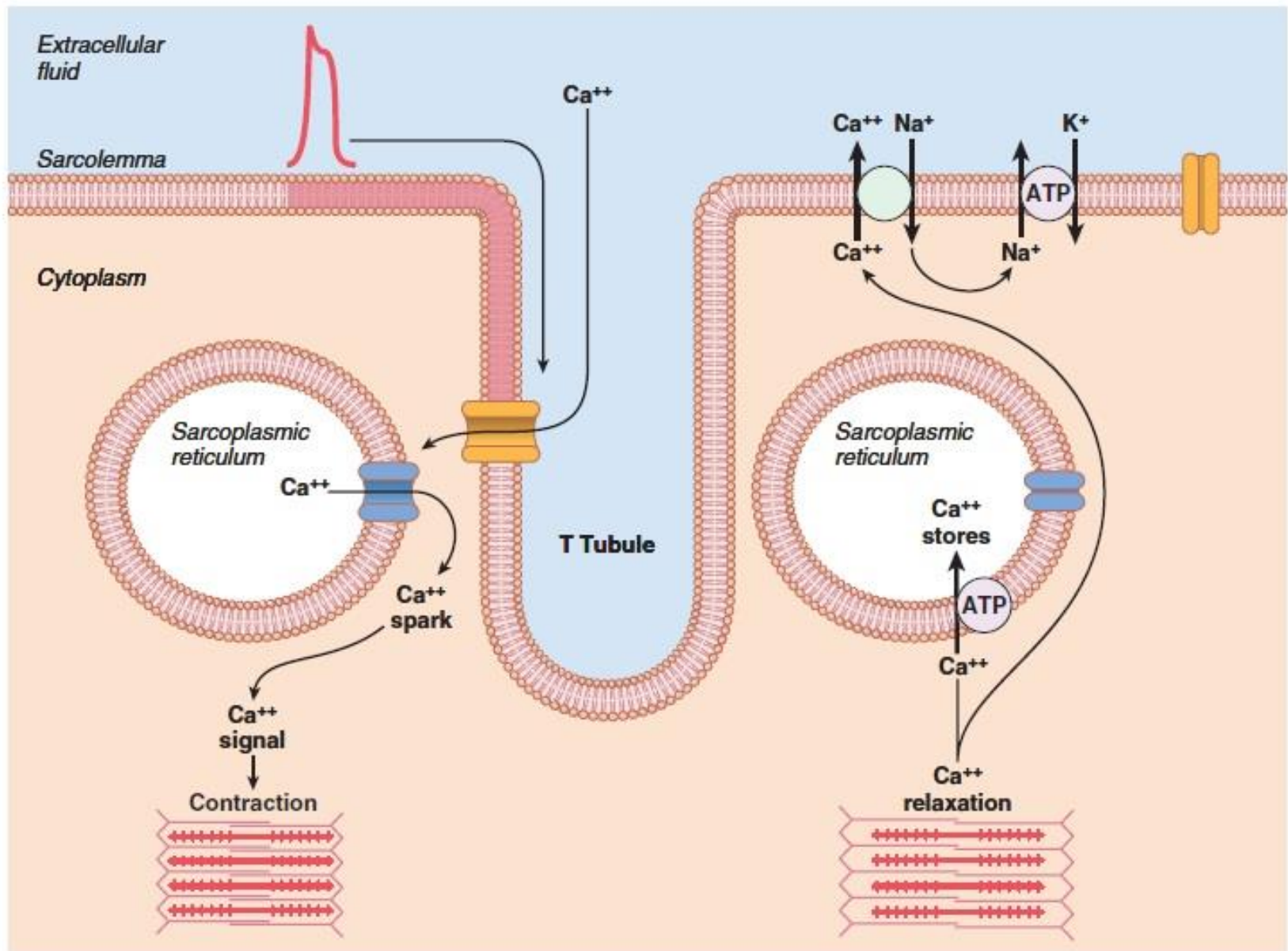

Mechanisms of excitation-contraction coupling and relaxation in cardiac muscle. ATP, adenosine triphosphate.

Test Question:

Q. Action potential of the SA nodal fiber is usually caused by?

- A. Closure of fast sodium channels.
- B. Opening of fast sodium channels.
- C. Opening of potassium channels.
- D. Opening of slow calcium-sodium channels.
- E. Opening of sodium and potassium channels.